

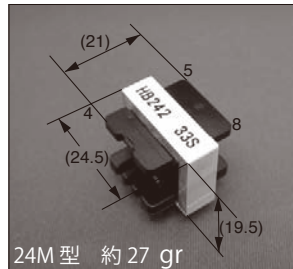

High Quality Transformers

ハイブリッドトランス例

HB24-2 ハイブリッドトランス



24M型 約 27 gr

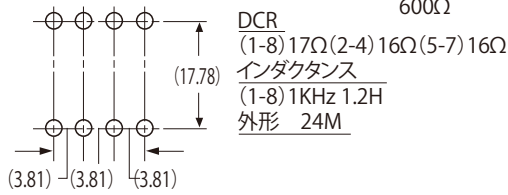
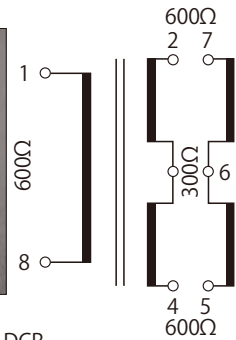

HB24-3 整合トランス

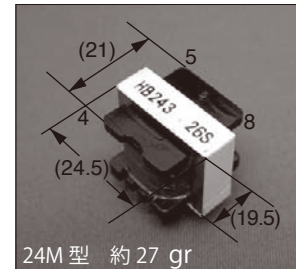

24M型 約 27 gr

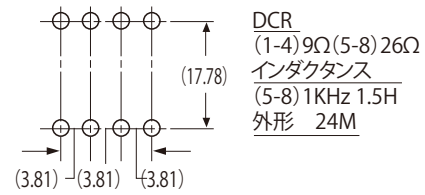
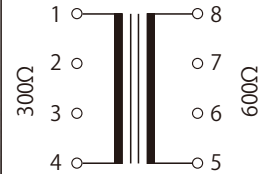

HB24-2

(試作時実測参考データ)

f	60	0.1	0.2	0.3	1	6	10	15	20	30	50KHz
Zp (1V)	513	538	562	574	598	623	636	653	676	728	891 Ω
Loss (1V)	1.15	0.95	0.8	0.75	0.6	0.45	0.45	0.45	0.50	0.55	1.1dB
鳴音	67.2	66.5	66.6	67.0	66.9	65.3	64.6	63.0	61.7	59.8	56.8dB

HB24-3

(試作時実測参考データ)

f	60	0.1	0.2	0.3	1	6	10	15	20	30	50KHz
Zp (1V)	268	278	288	293	303	315	323	333	347	383	485Ω
Zs (1V)	526	548	572	583	603	628	641	667	698	777	1006Ω
Loss (1V)	1.1	0.9	0.8	0.75	0.55	0.45	0.45	0.55	0.60	0.85	1.5dB

ハイブリッド組合せ例

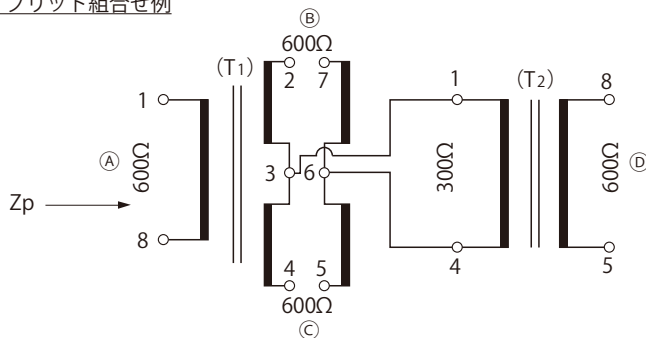

T₁ : HB24-2

T₂ : HB24-3

HB24-2 と HB24-3 組合せ

(試作時実測参考データ)

f	30	60Hz	0.1	0.2	0.3	1	3	6	10	15	20	25	30	50KHz	
Zp	1V	464	507	531	556	566	589	603	614	624	642	665	689	721	888Ω
Ⓐ⇔Ⓑ, Ⓒ	1V	1.5	1.1	0.95	0.75	0.70	0.55	0.50	0.40	0.40	0.45	0.50	0.55	0.60	1.10dB
Ⓐ⇔Ⓓ	※ ₁	45.3	42.3	41.2	40.3	40.1	39.7	39.6	39.5	39.5	39.6	39.8	40.1	40.4	42.2dB
Ⓓ⇔Ⓑ, Ⓒ	1V	1.35	1.05	0.90	0.75	0.70	0.55	0.45	0.40	0.40	0.45	0.50	0.55	0.60	1.20dB
Ⓑ⇔Ⓒ	※ ₂	30.2	31.4	33.7	34	34.5	35.1	35.3	32.5	31	28.8	26.6	24.5	22.7	16.3dB
Ⓑ⇔Ⓐ	1V	1.5	1.2	1.0	0.8	0.75	0.55	0.50	0.40	0.40	0.45	0.50	0.55	0.65	1.10dB
Ⓑ⇔Ⓓ	1V	1.65	1.35	1.15	0.95	0.90	0.80	0.65	0.65	0.65	0.65	0.70	0.80	0.85	1.40dB

※₁ 指示値 -3dB ※₂ 指示値のまま